

A	B	C (mm)		D
1	S328-005	444	200	5/5
2	S328-006	444	200	5/5
3	S328-007	444	200	5/5
4	S328-011	1716	444	5/5
5	S328-012	1716	444	5/5
6	S328-116	1964	585	1/5
7	S328-117	1964	585	1/5
8	S328-118	1928	557	2/5
9	S328-119	198	541	4/5
10	S328-205	1480	615	3/5
11	S328-310	1348	577	3/5
12	S328-311	890	541	2/5
13	S328-312	442	541	4/5
14	S328-313	890	541	2/5
15	S328-314	442	541	4/5
16	S328-315	441	520	4/5
17	S328-910	1938	899	1/5
18	S328-911	1938	451	1/5
19	S328-912	415	505	2/5
20	S328-913	405	505	2/5
21	ZS3-5533	393	120	4/5
22	ZS3-5640	383	120	4/5
23	ZS4-505	500	120	4/5
24	ZS4-506	500	120	4/5
25	dr-885x30	885	30	3/5

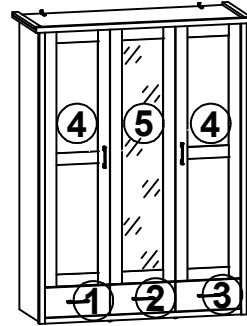

cm

4x hamulec K16, 435 a101	2x hamulec K9, 435 a103	4x K16 a43	2x K9,5 a68
2x D1,5 b33	4x D3 b35	6x b59	5x 128 mm c406
18x Ø6,3x10 mm e50	24x Ø6,3x10 mm e51	16x Ø8x30 mm f1	6x Ø6x30 mm f9
12x Ø5x17 mm d1	18x d20	24x d28	12x Ø6x13 mm e3
10x M4x25 mm j8	6x k1	2x M6/Ø14x14 mm k3912	18x Ø5x9 mm e19
12x Ø6,5x40 mm f25	36x 20/11 r42	3x 500 mm w26\DL	2x M6/22 mm k3913
13x Ø3,5x16 mm p38	24x Ø3,5x15 mm p51	3x 500 mm w26\DR	22x i2
6x Ø3x12 mm p54	24x Ø15x12 mm #16 r1	3x 500 mm w26\CR	2x 81x21x15/1,5 n14
12x Ø12x10,5 mm #12 r15	10x s2	3x 500 mm w26\CL	2x n158
3x 500 mm w26\CR		3x 500 mm w26\DL	2x Ø3,5x13 mm p1

1

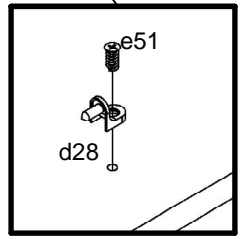
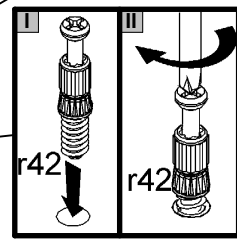
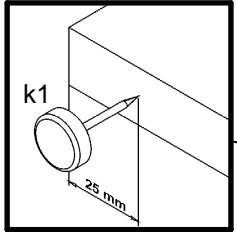
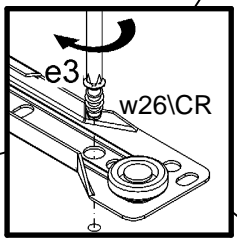
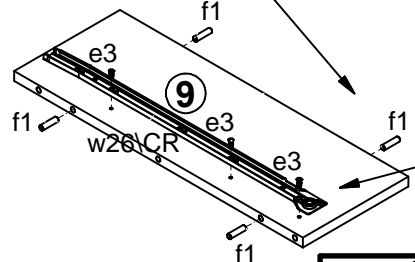
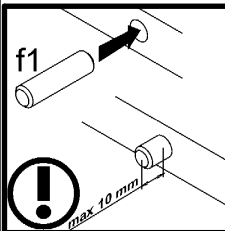
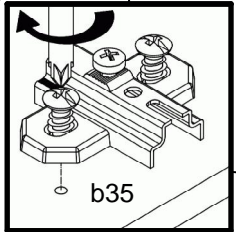
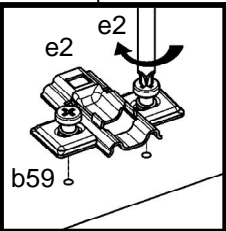
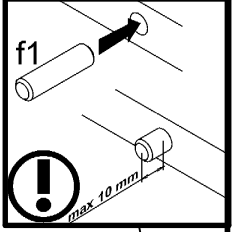
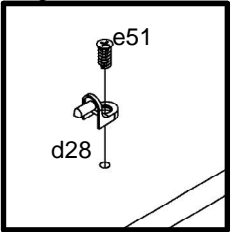
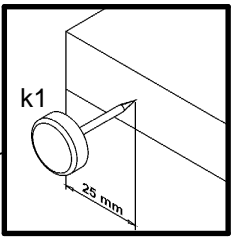
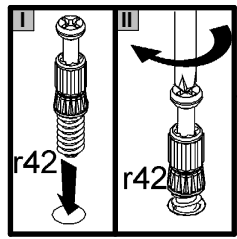
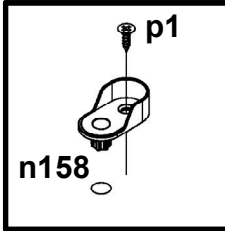
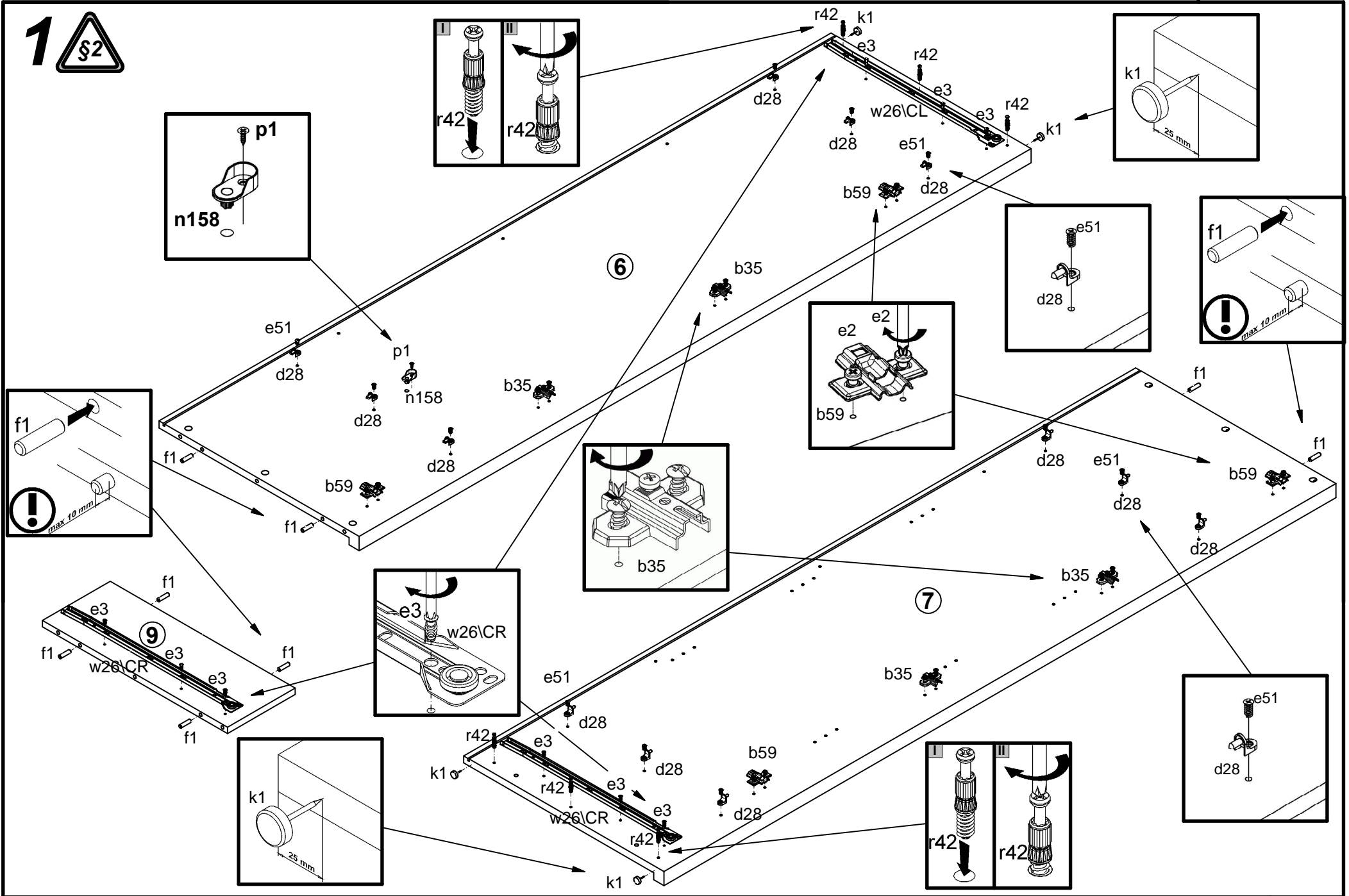

2

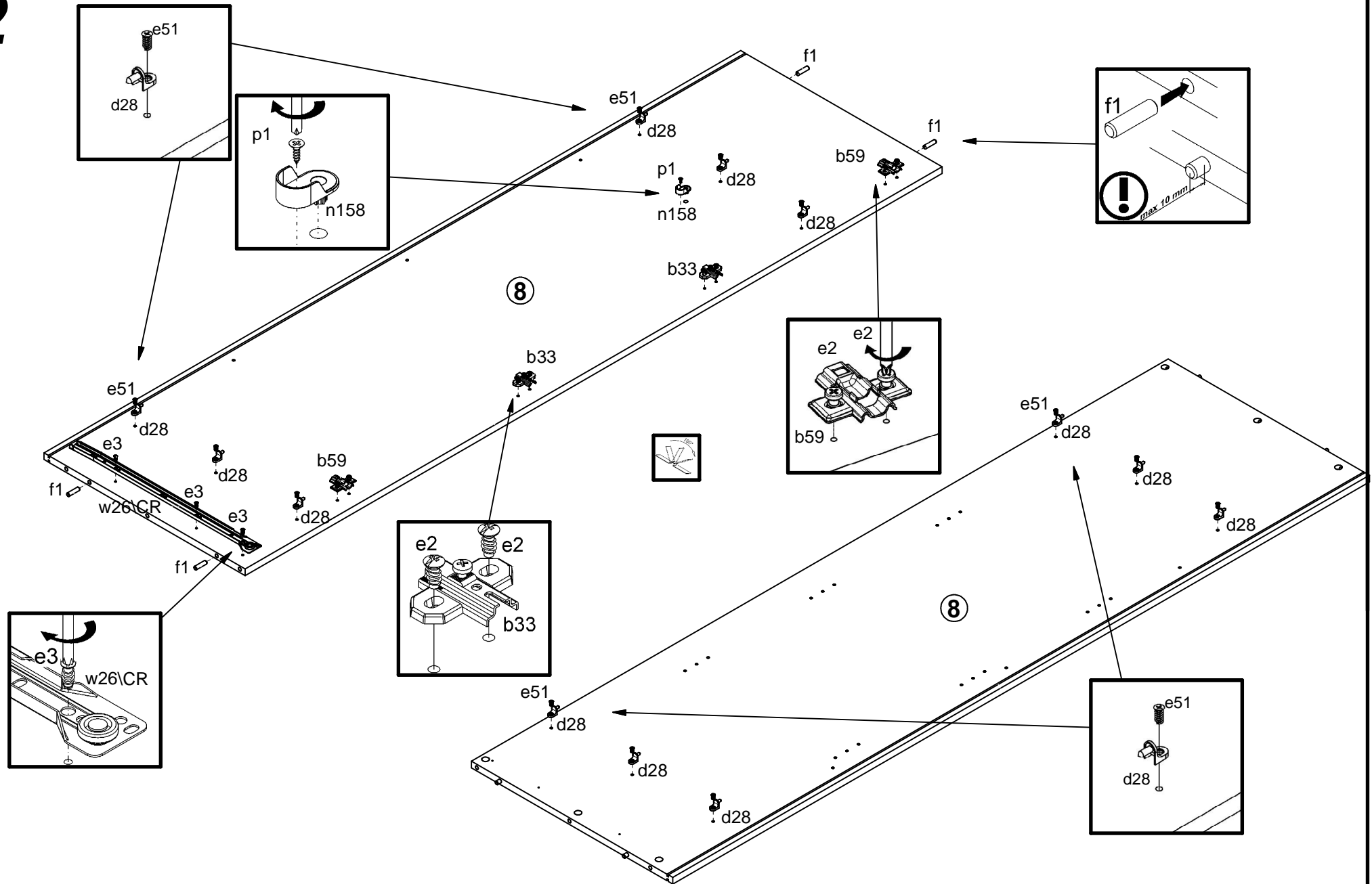

3

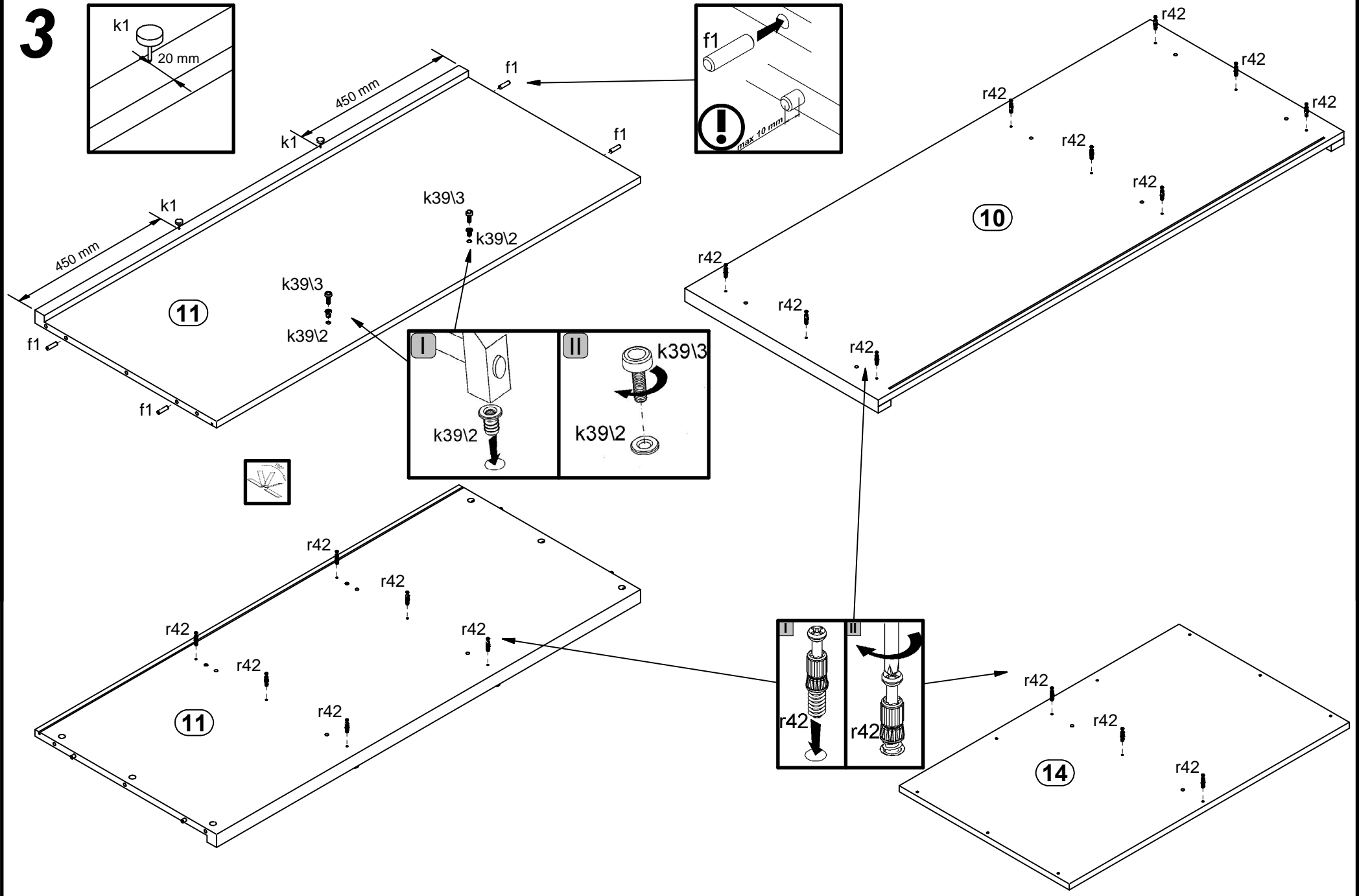

4 §6

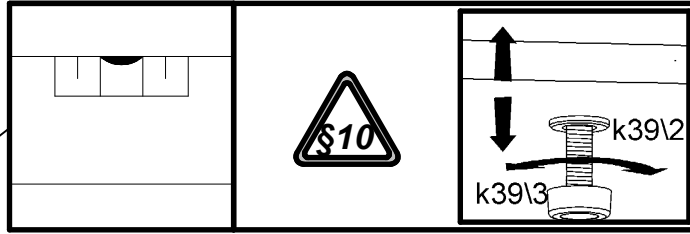

I

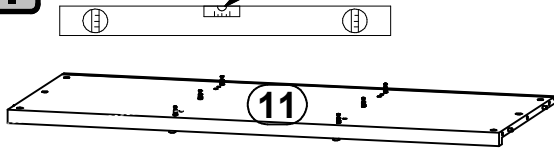

II

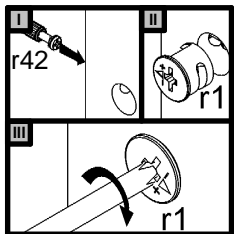
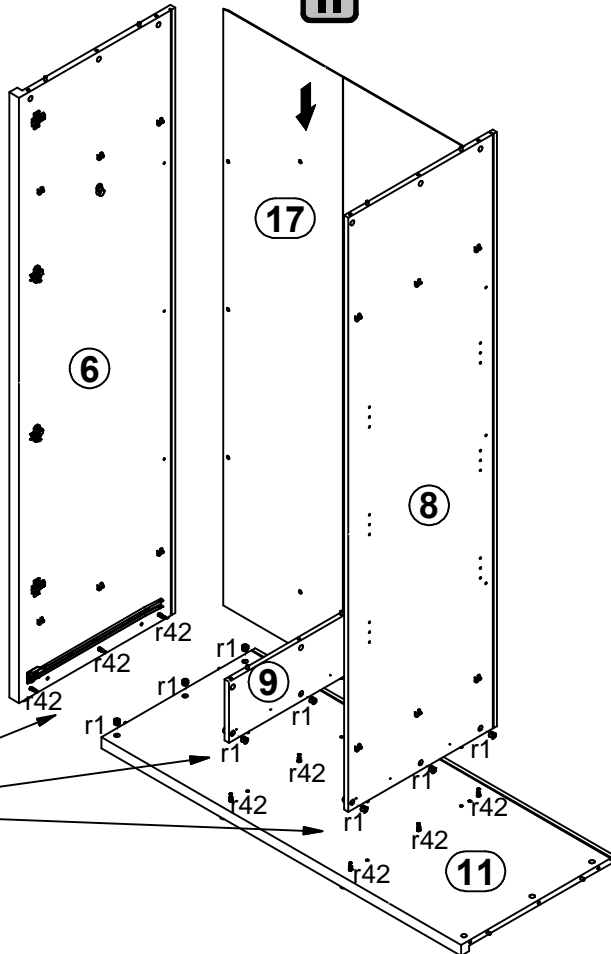

III

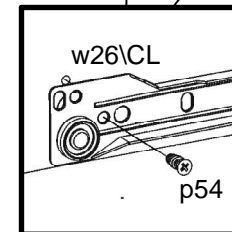
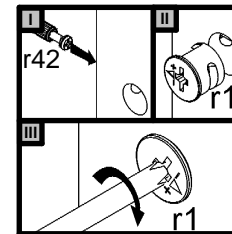
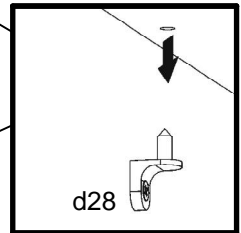
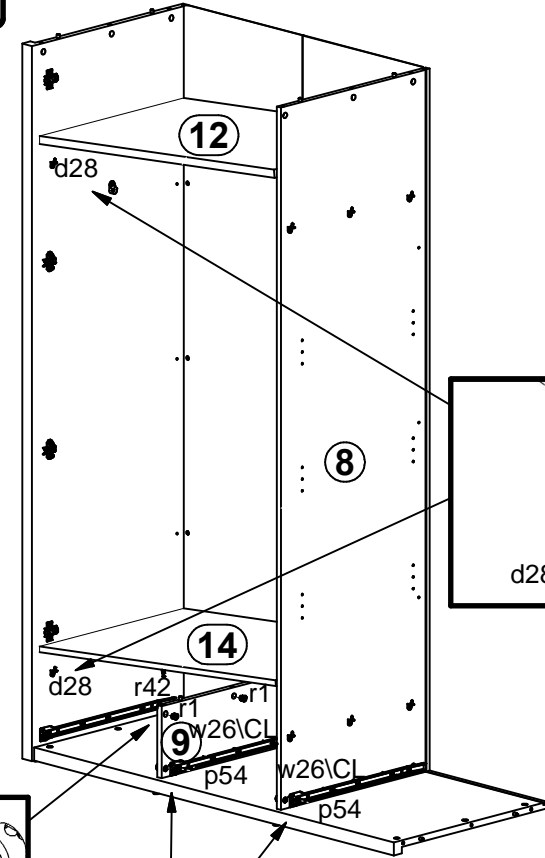

5

I

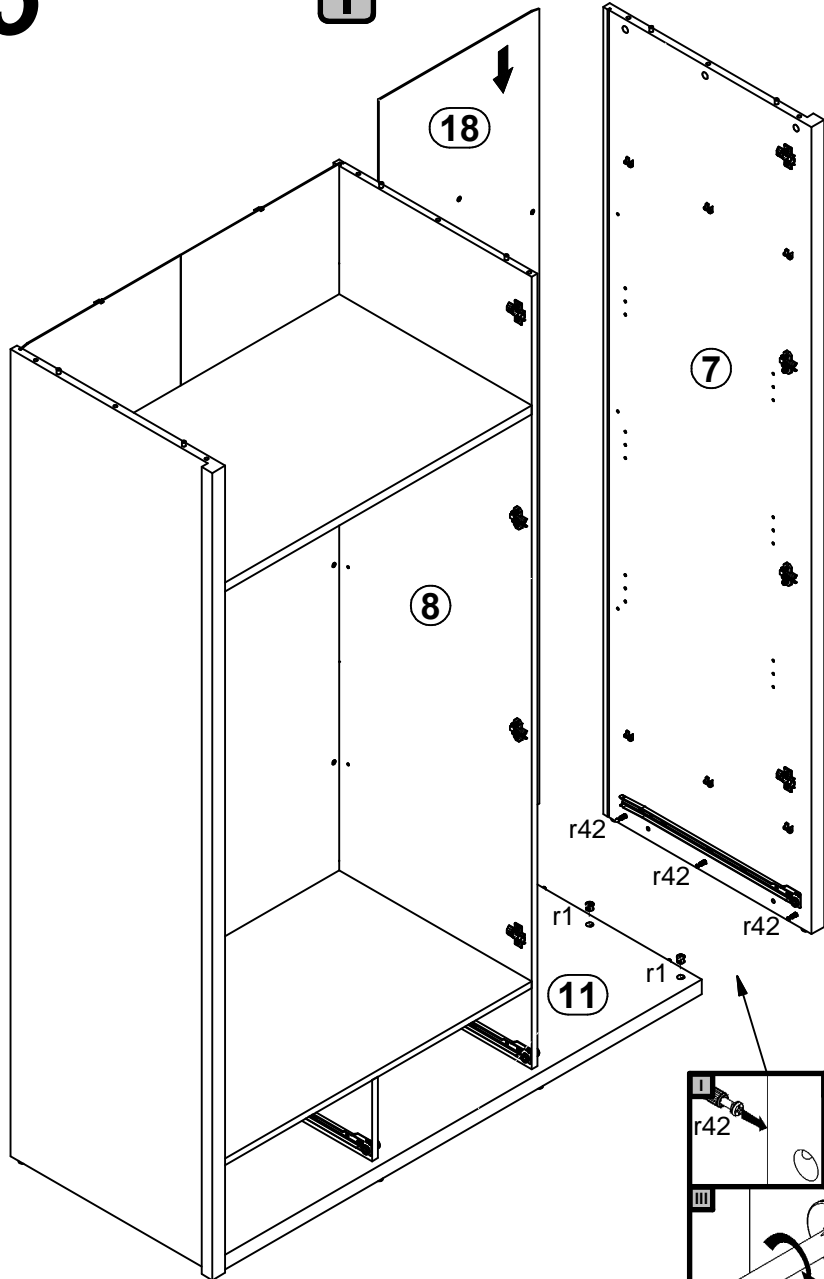

III

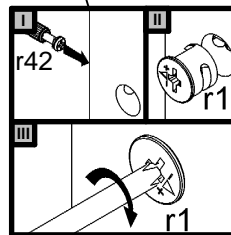
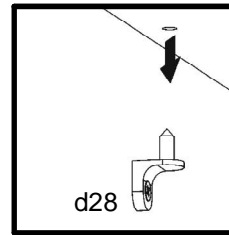
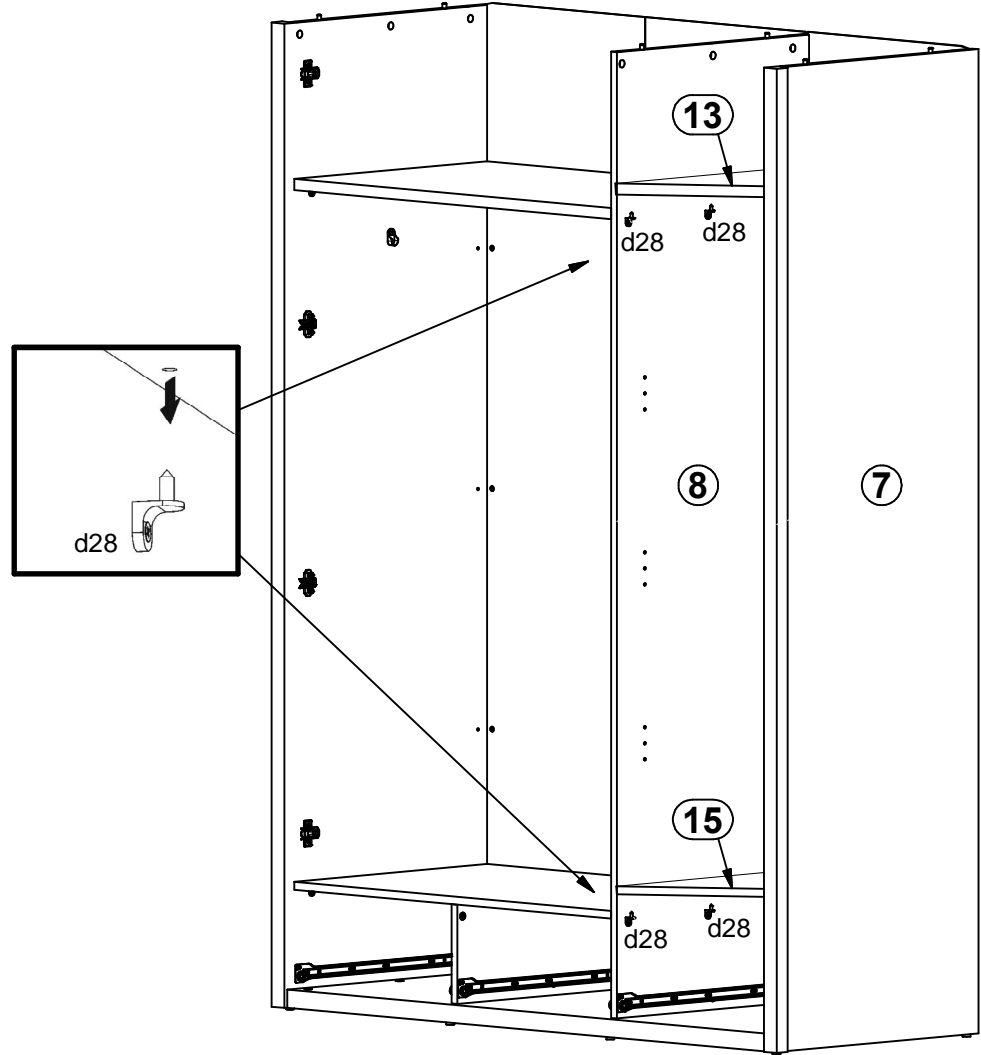

6

I

II

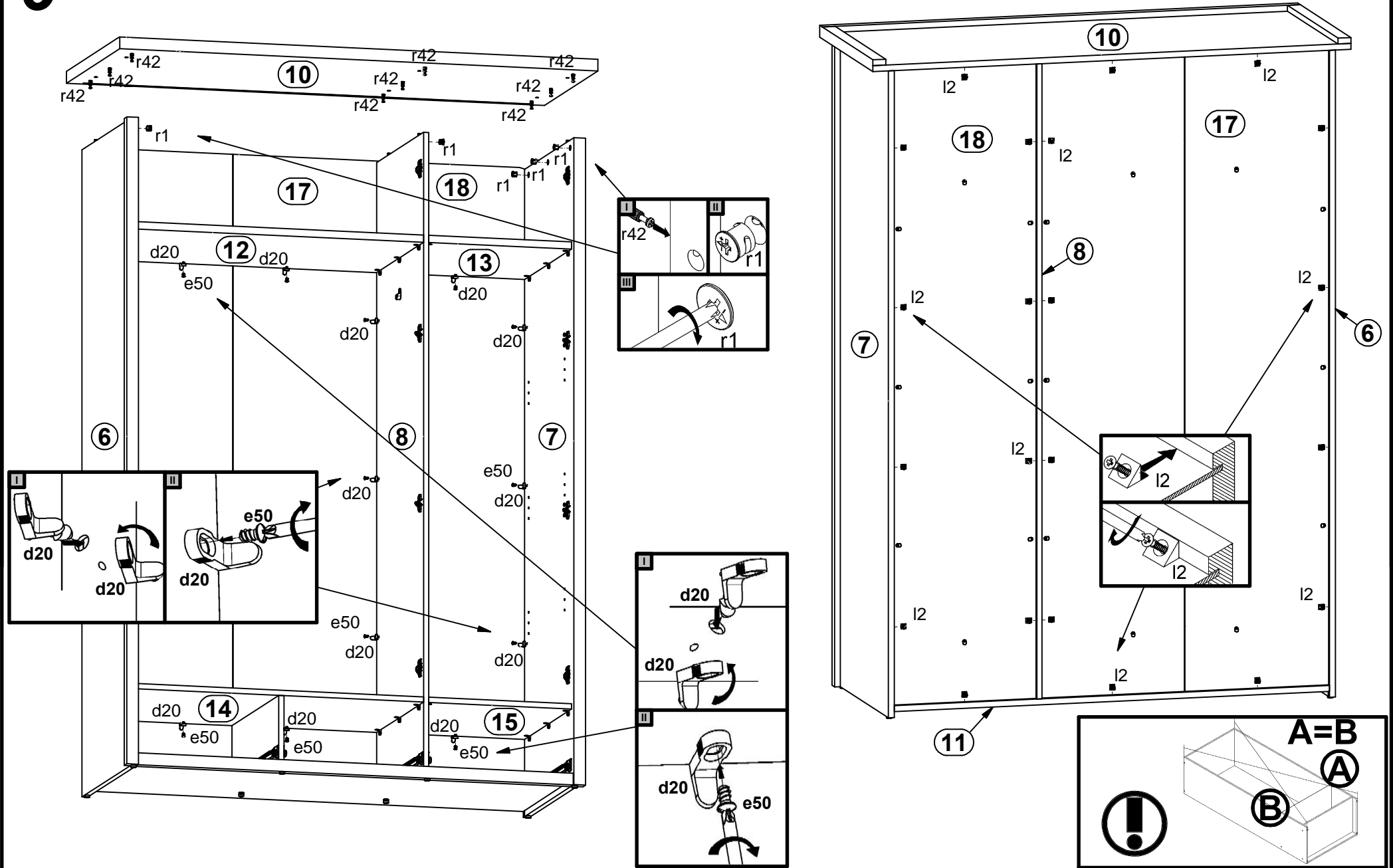

7

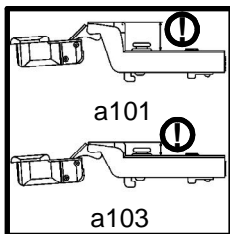
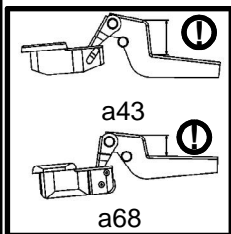
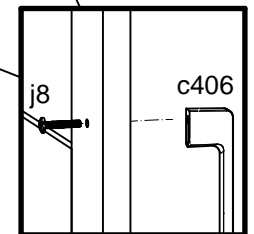
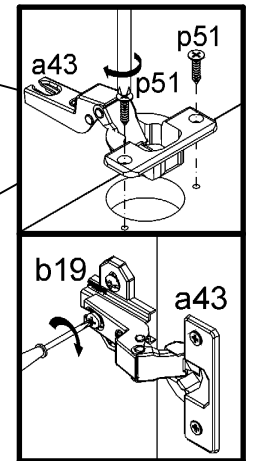
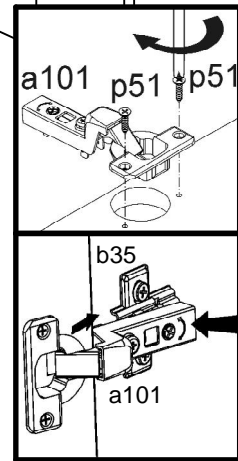
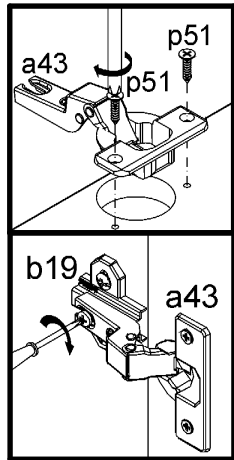
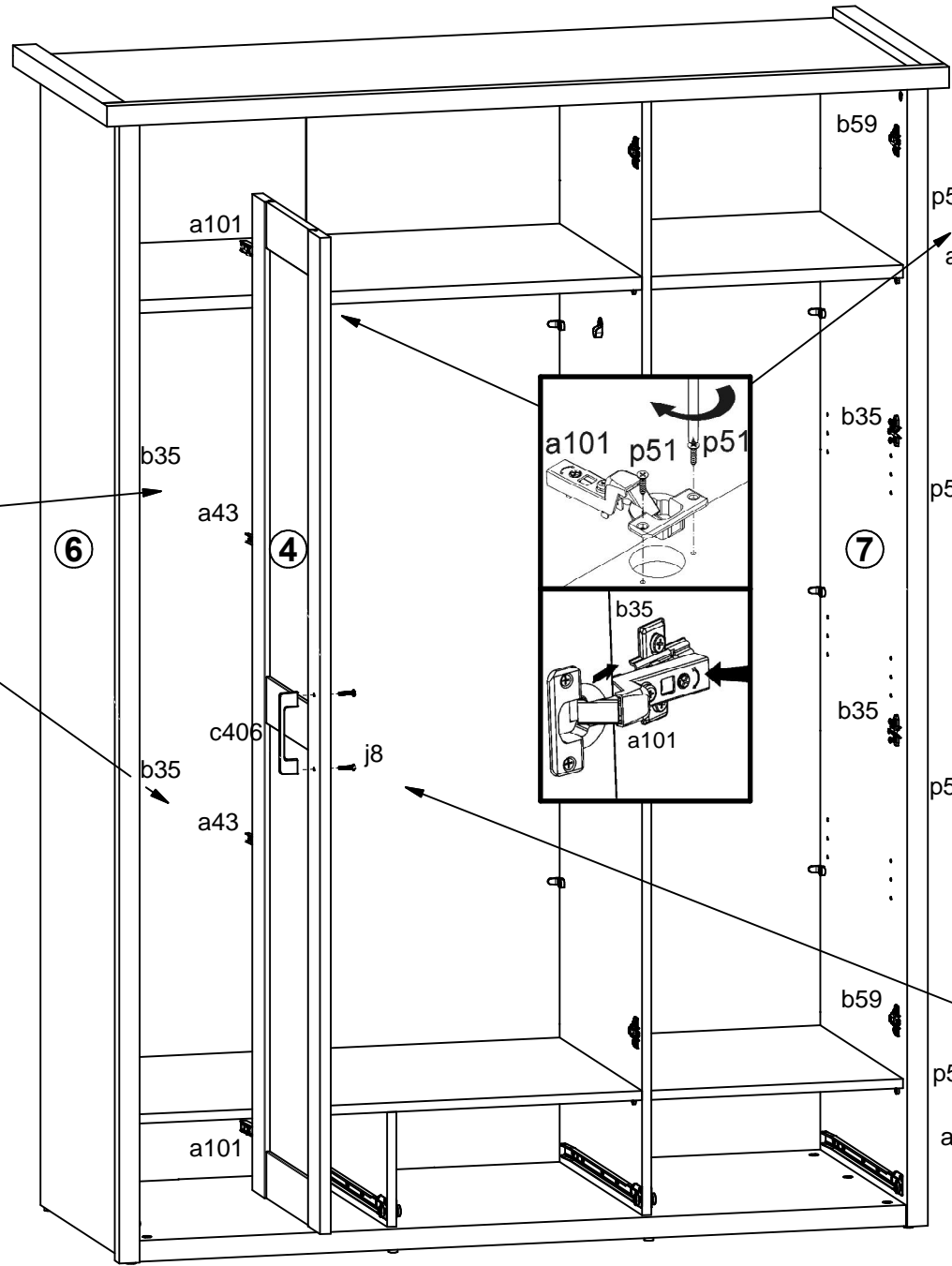

8

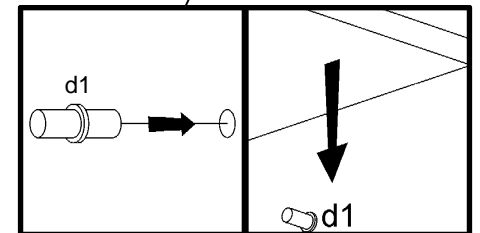
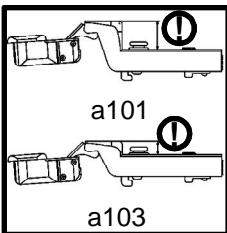
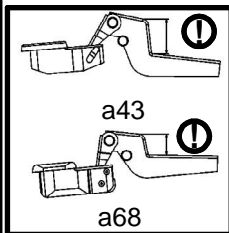
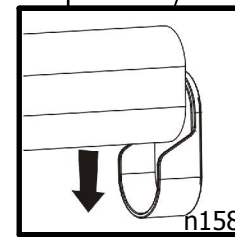
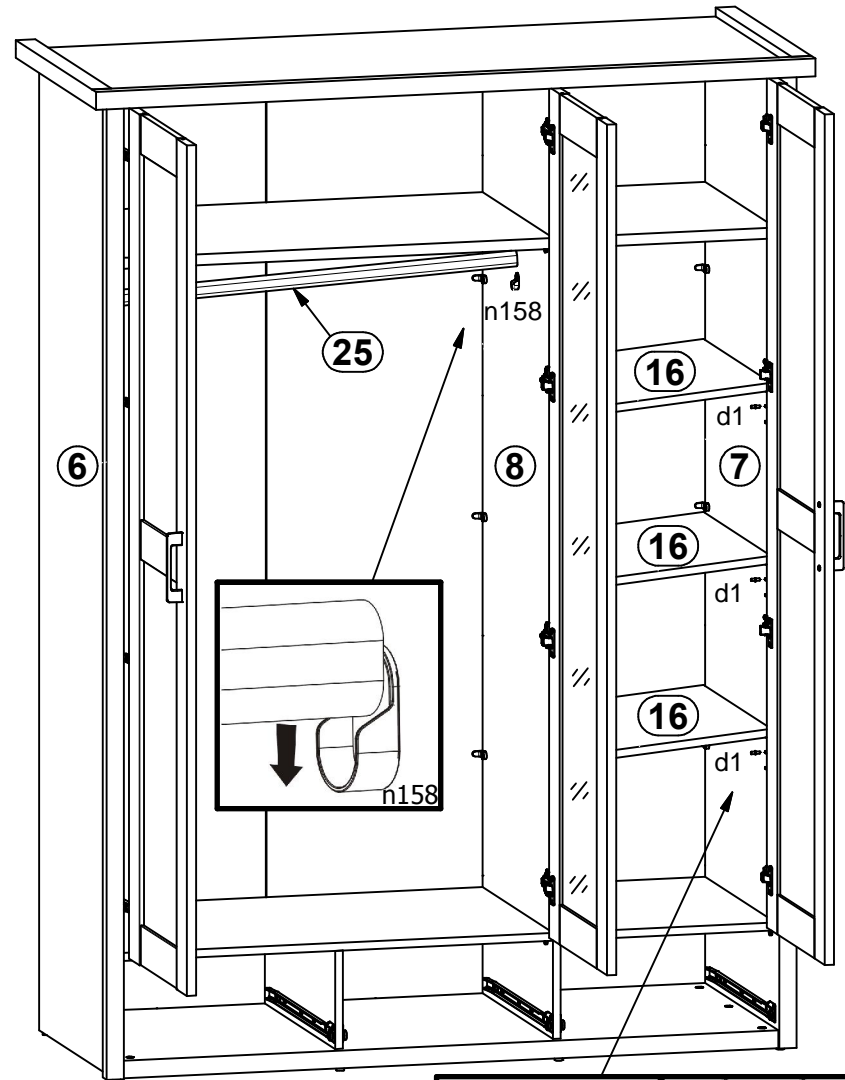
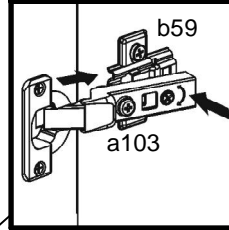
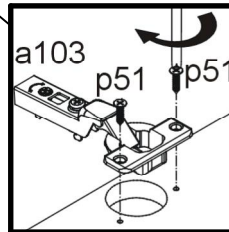
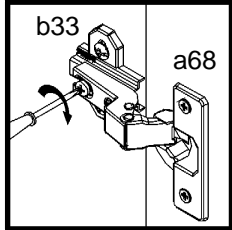
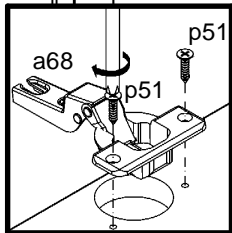
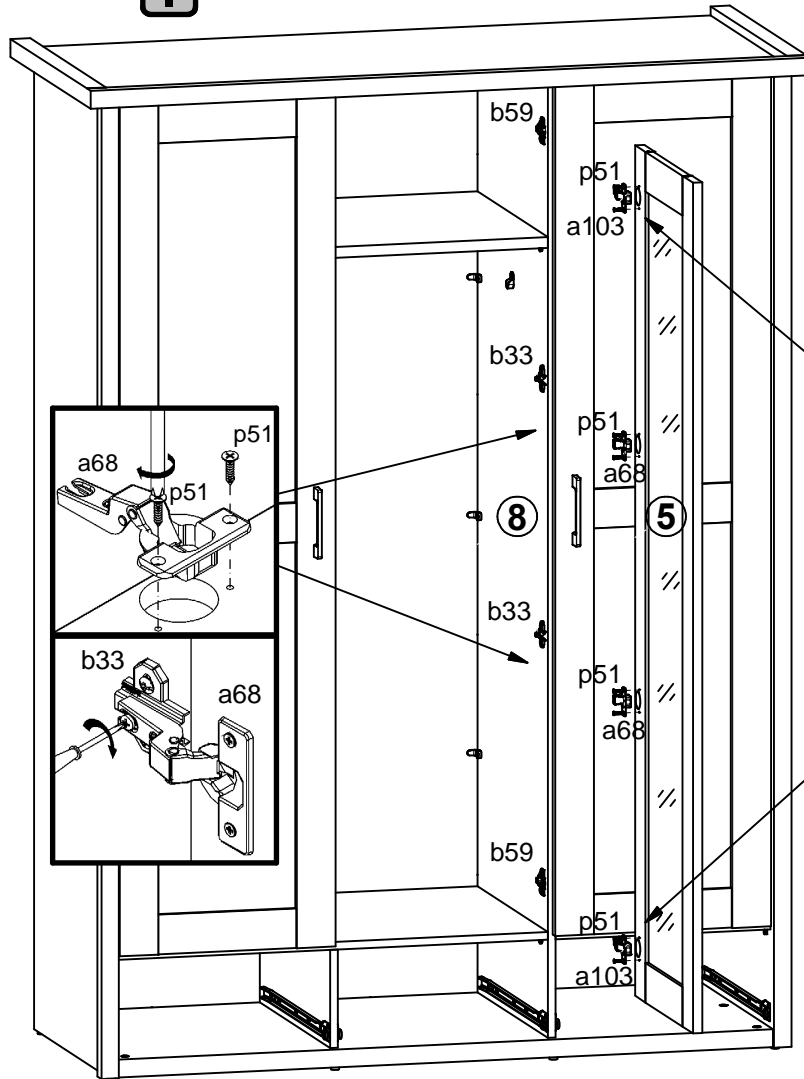

10

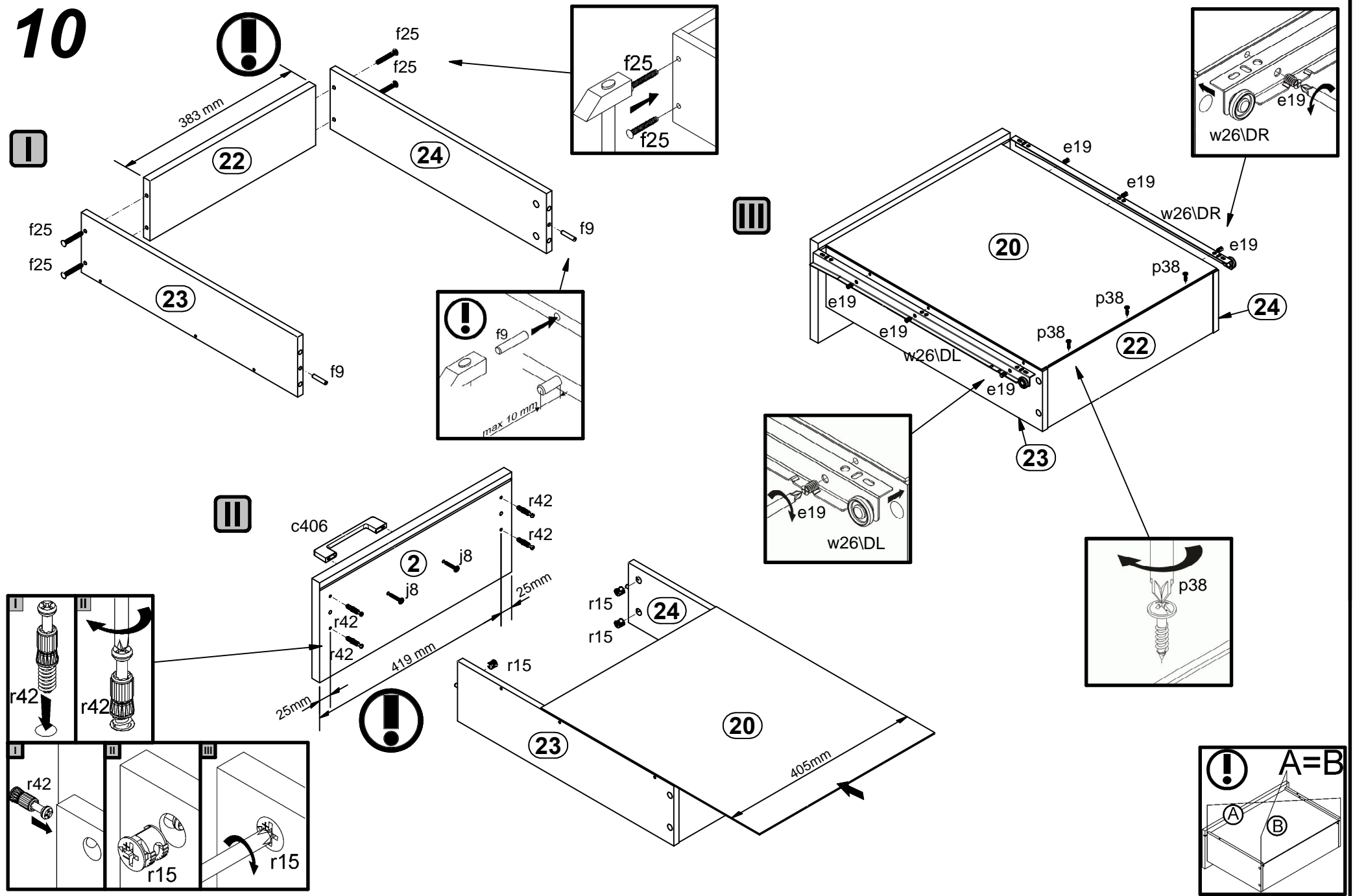

11

